

CE
2460

Optiflex
TRIO
IOLs RANGE

**DESIGNED
TO MEET
YOUTHFUL
VISION**



biotech

VISION CARE

Optiflex TRIO is diffractive-refractive trifocal intraocular lens used for presbyopia correction.

Its unique diffraction pattern gives balanced light distribution at all distances and results in spectacle independence for vision.

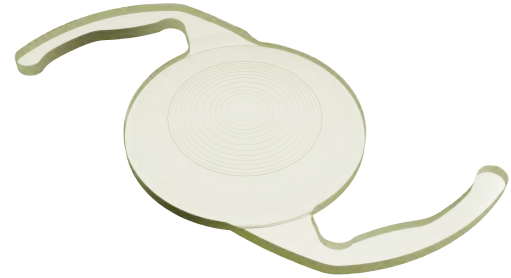

BLISS (Brilliant Light Sensing System) Technology

- Designed for Natural Adaptation
- Effective utilization of unused light energy
- Optimum asymmetric and balanced light distribution at each focal point
- Specially optimized diffractive zones for intermediate & near vision without affecting distance vision
- Pupil independent

Unique Refractive Diffractive Aspheric Design

- Optimized center zone (Refractive Zone) supports angle Alpha + Kappa & minimizes haloes and glares
- Optimized 4mm diffractive zone reduces dependence on pupil size
- Peripheral refractive zone supports the distance vision in low light condition (Scotopic condition)

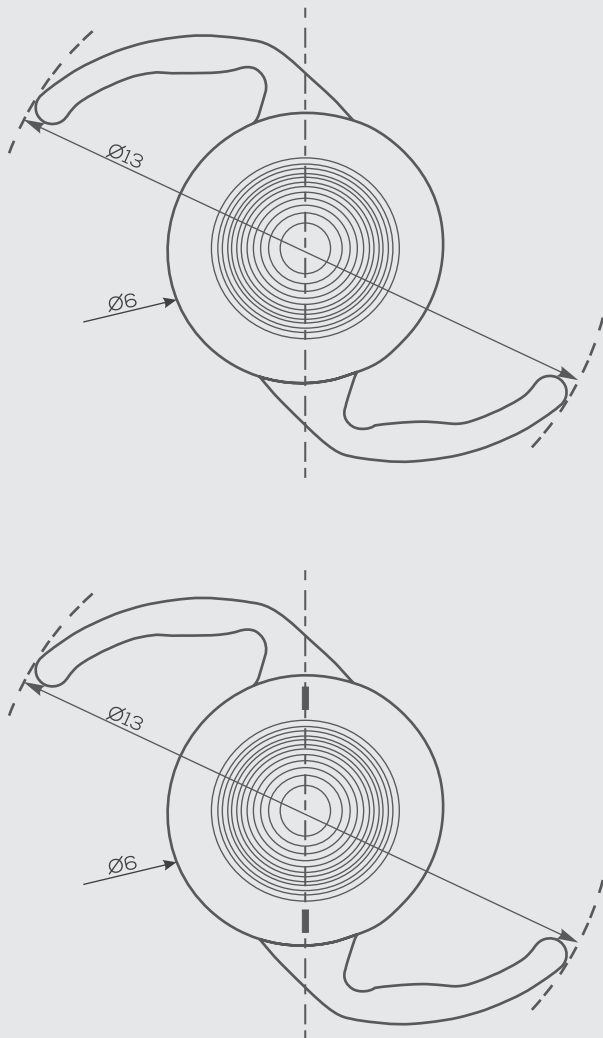

Top and side view
of the Optiflex Trio²

Aspheric / Aspheric Toric
Anterior Diffractive Surface

OPTIFLEX TRIO FEATURES

- Uninterrupted functional vision
- Smooth transition between zones – minimizes glare and halos
- Glistening free
- Minimized dysphotopsia
- Optimized near add power of +3.5 D works for ideal reading distance at about 38 cm and intermediate add power of +1.85 D works for vision at about 72 cm
- Optimum Asymmetric and balanced light distribution of 45% for far, 27% for intermediate and 28% for near- distances, provides excellent vision at all distances
- Reduces dependency on spectacles, matches the active lifestyle for today's patients
- Excellent Post-operative results maximize patient satisfaction
- Maximum light transmittance, which gives best quality vision in all lighting conditions
- Wide range of cylindrical correction

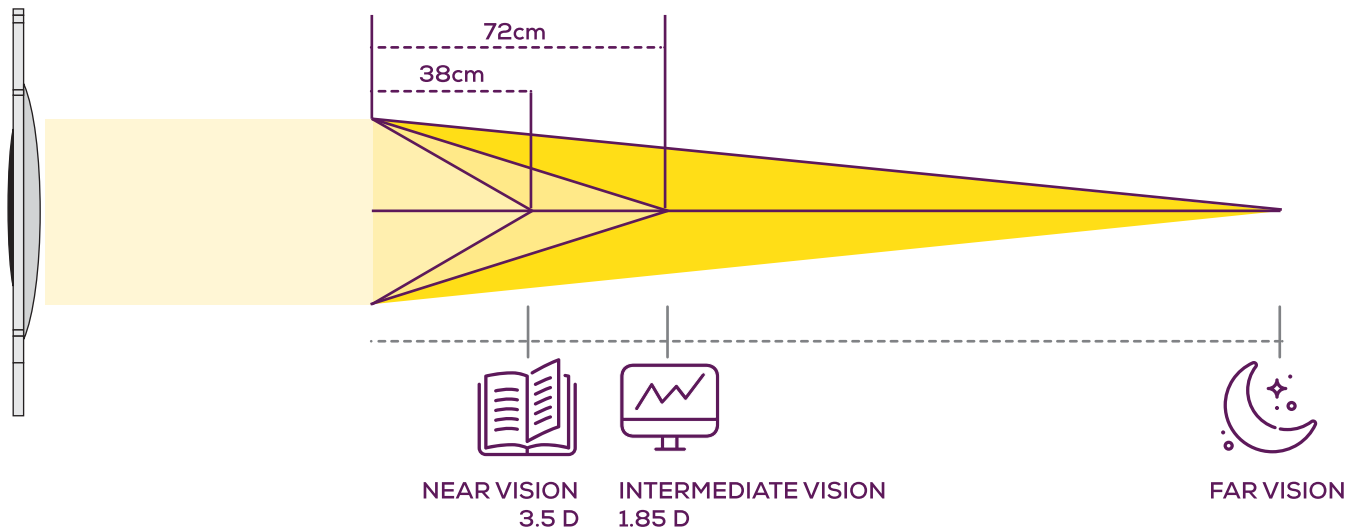

GENERAL FEATURES

- Lens material with natural yellow chromophore prevents risk of Age Related Macular Degeneration (ARMD) and doesn't disturb the circadian rhythm. Moreover, it doesn't attribute to altered color perception, hence enhances the contrast sensitivity
- Aspheric optic with negative S.A neutralizes the positive S.A. of cornea and gives crisp and clear vision
- High Abbe Number of 49 results in decreased amount of chromatic aberration
- Provides excellent post-operative results and a superior behavior for folding and unfolding
- 360° square edge design and increased bio-adhesion to the posterior capsule, postpones PCO
- Smooth lens surface reduces bacterial adhesion and inflammatory cell response



DEFOCUS CURVE³

The defocus curve of the Optiflex TRIO shows un-interrupted post-operative visual outcomes for distant, intermediate and near objects.

Optiflex TRIO provides extended range of 35-90 cm between intermediate & near vision, for daily activities.

Positive portion of the defocus curve proves the tolerance for refraction errors for distance vision, occurred during pre-operative measurements due to either human or instrumental errors.

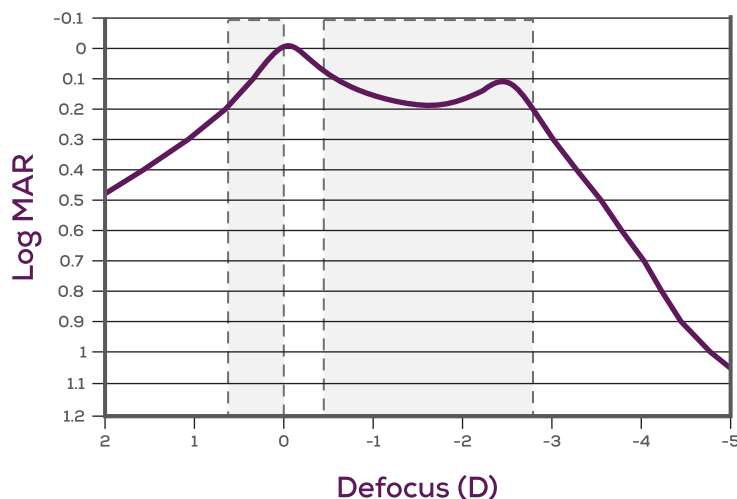

Defocus curves showing avg. visual acuity of patients Implanted with Optiflex TRIO

POST-OPERATIVE REFRACTIVE OUTCOMES³(n=69)

This graph shows the post-operative results for spherical residual. 92% patients are within ± 0.25 D spherical residual post-operatively, and 97% patients are within ± 0.5 D spherical residual post-operatively.

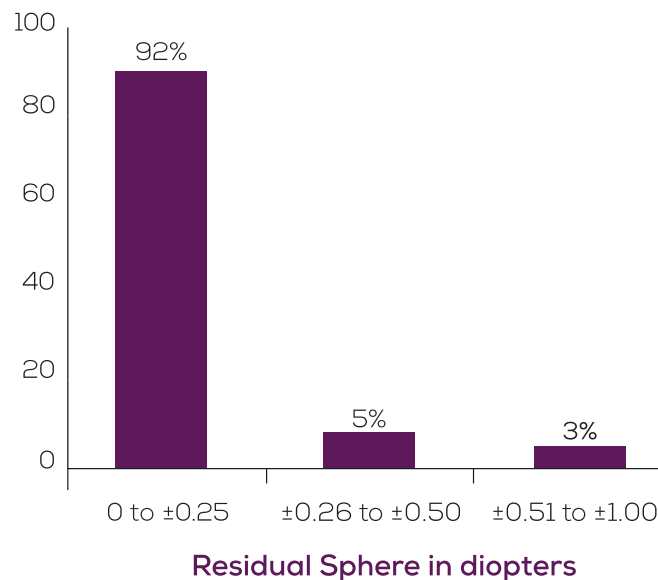



VISUAL ACUITY³

Uncorrected visual acuity (n=69)

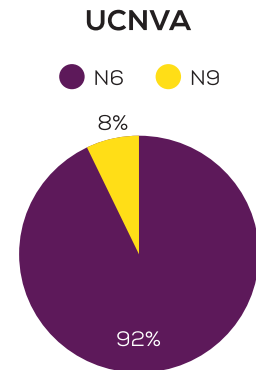
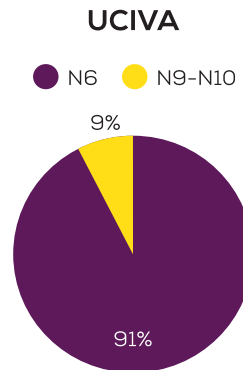
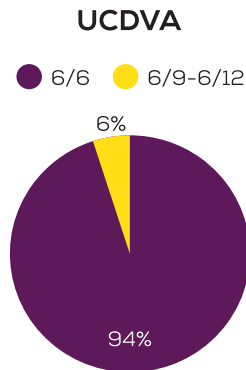

Uncorrected distance visual acuity (UCDVA) is given in above charts. The results show excellent performance of the lens. 94% of the patients get their normal distant vision back. 91 % of them get their normal intermediate and 92% of them get their normal near vision back. As claimed, Optiflex TRIO gives true spectacles independence to patients thus giving them clear vision at all distances, near, intermediate-far, adhering to their daily lifestyle needs.



Best corrected visual acuity at different distances (n=69)

Best corrected distance visual acuity (BCDVA) is given in below charts. The results show excellent performance of the lens. 100% of the patients regained their normal far vision. 95% of them regained their normal intermediate and 97% of them regained their normal near vision.

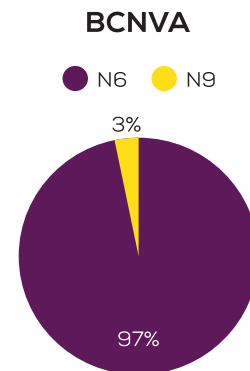
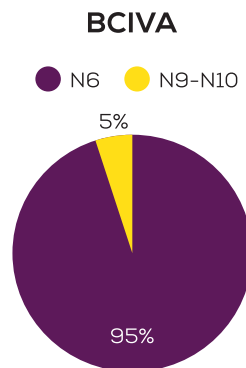
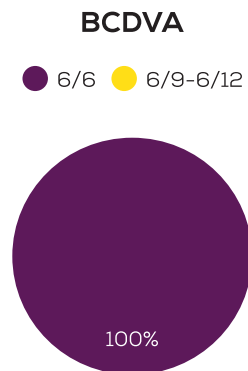

ROTATIONAL STABILITY³ (n=69)

Excellent rotational stability due to advanced hydrophobic material and larger overall length of the lens. Rotational stability for 94% cases, has been observed within 0°- 5° & rotational stability for 100% cases, has been observed less than 10°.

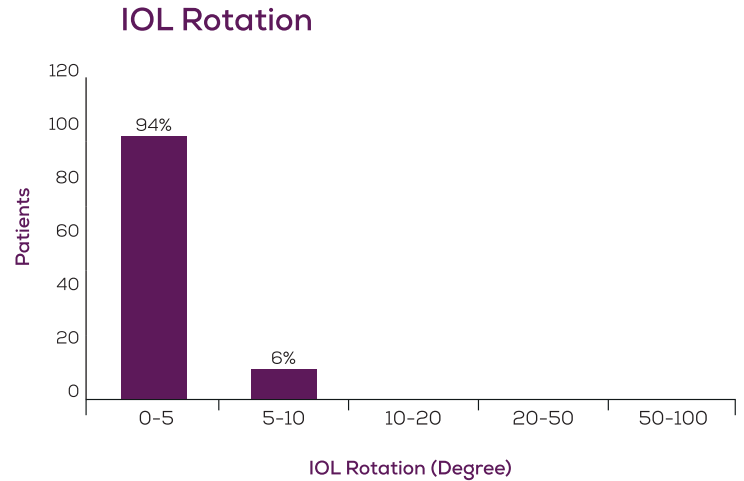

RESIDUAL CYLINDER POWER³ (n=69)

Clinical results of Optiflex TRIO show very good post-operative results. In 77% cases, residual cylinder measured is within +/- 0.25D & in 93% cases, residual cylinder measured is within +/- 0.50D.

These post-operative cylindrical results prove excellent rotational stability for Optiflex TRIO.

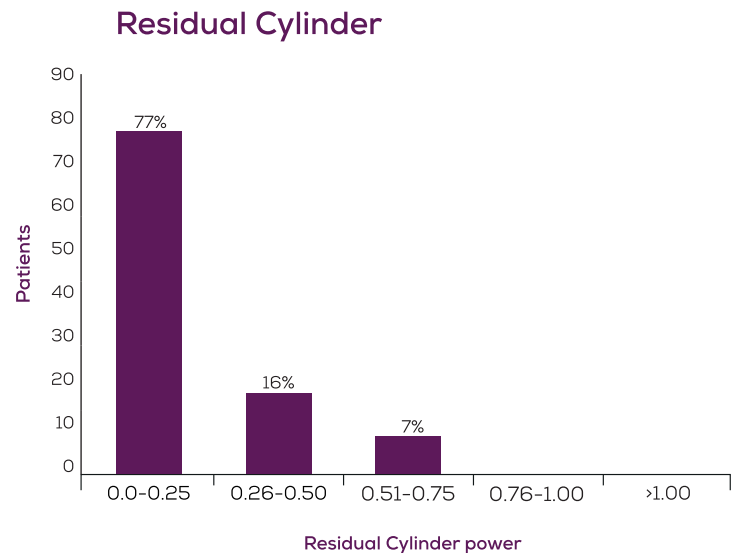



REFRACTIVE STABILITY³ (n=69)

Post-operative refractive stability is crucial for long term gain in vision. Optiflex TRIO provides stable vision to patients after surgery³.

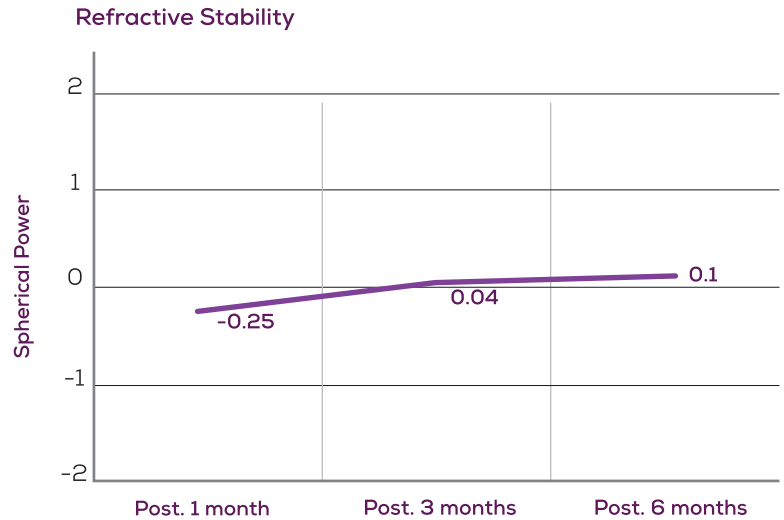

Post-operation refractive stability of patient implanted with Optiflex TRIO



GLARES AND HALOS ³ (n=69)

Multiple focal lengths of IOL project three images on retina simultaneously, out of which two will be defocused causing Glare and Halos in patient's eye. On the basis of its effect on human vision, it can be classified in mild and severe categories. This graph represents two categories of Glare and Halos phenomena in patients implanted with Optiflex TRIO. Only 7% of patients experience mild Glare and Halos and none of them reported of a severe category.

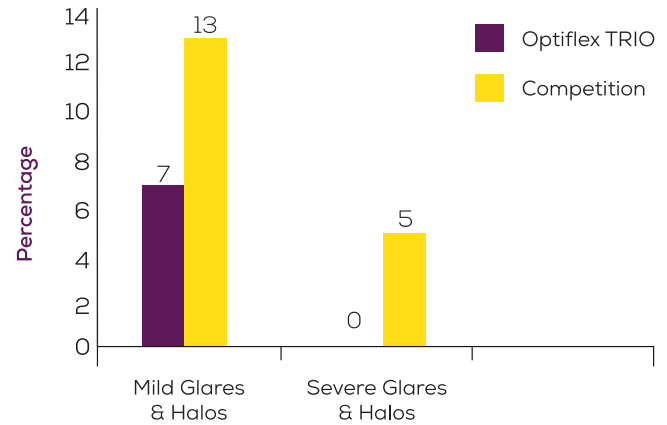

Percentage distribution of Glares & Halos phenomena in patients implanted with Optiflex TRIO

READING SPEED ³ (n=69)

This graph shows the distribution of patients on the basis of reading speed. 84% of patients with Optiflex TRIO were able to read faster after implantation, as compared to competition.

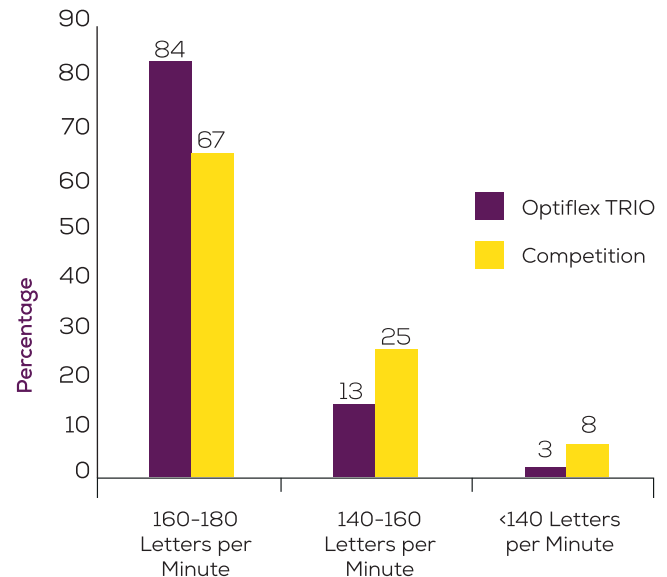

Percentage distribution of reading speed of patients implanted with Optiflex TRIO

LIGHT ENERGY DISTRIBUTION

(%) at various Pupil sizes ²

The Relative Energy distribution of Optiflex TRIO in different lighting conditions like Photopic & Scotopic, is shown in this graph. It shows the light distribution in far, intermediate and near distances at various pupil sizes.

Energy Distribution at three focal points at various aperture size at 546 nm²

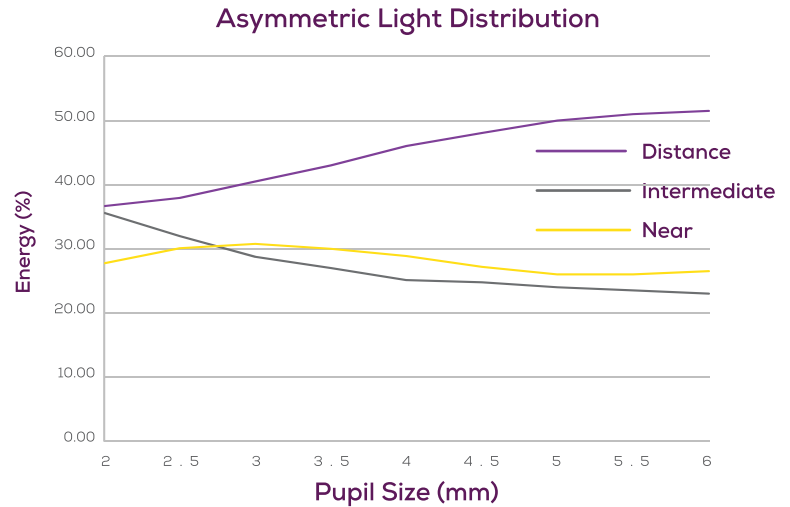

OPTIMIZED LIGHT DISTRIBUTION

Light Yield ²

- 88.3 % Transmitted light energy provides good quality of vision and improves contrast sensitivity
- Optimized diffractive zone ensures minimized pupil dependency in any lighting conditions



Optiflex TRIO, with its unique step design, exhibits minimum loss of light and yields 88.3% of light for sharp and clear vision at various distances.

MODULATION TRANSFER FUNCTION CURVE

(for standard model eye at 3 mm aperture and 50 lp/mm)²

- Optiflex TRIO delivers the best visual acuity at all distances
- Sufficient energy distribution at each focal point
- Clear separation of three peaks provides clear vision and excellent contrast at each focal point
- Extended depth of Intermediate provides extended range of quality vision for daily activities
- Covers 60-90 cm Intermediate distance without loss of contrast sensitivity

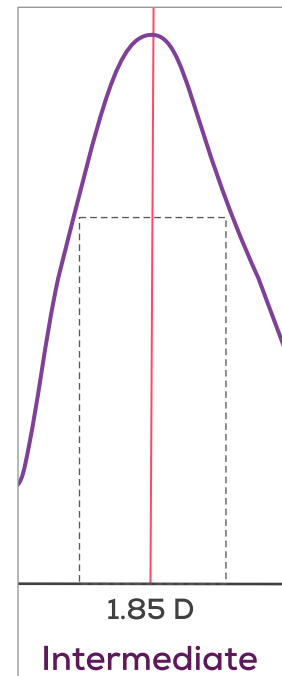
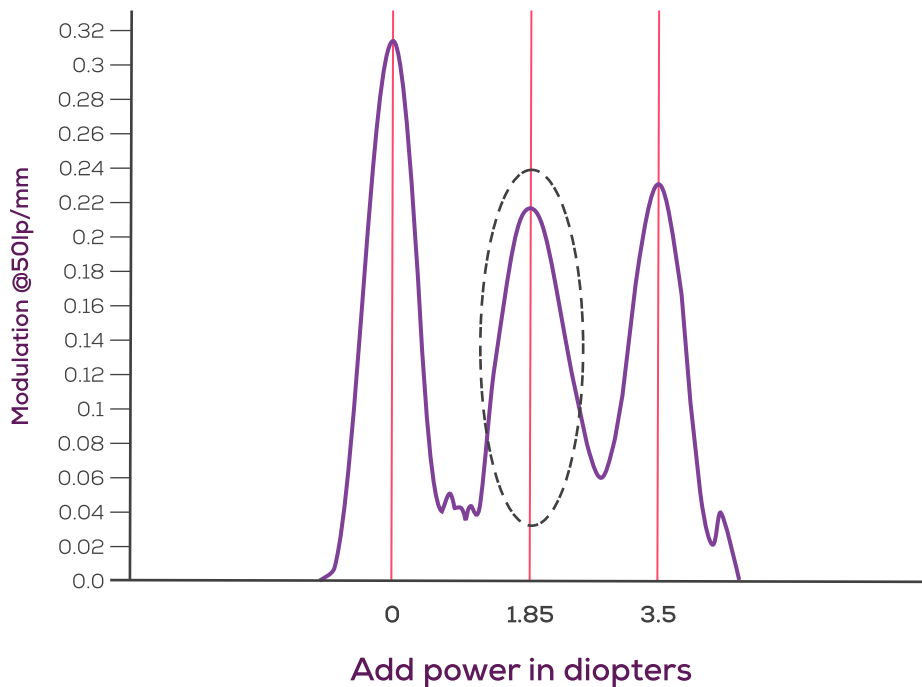

USAF RESOLUTION TARGET IMAGES

recorded for Biotech Optiflex TRIO²

USAF images given here show the qualitative resolution performance of Optiflex TRIO at various pupil sizes.

USAF images of Optiflex TRIO at various focal lengths for different aperture sizes

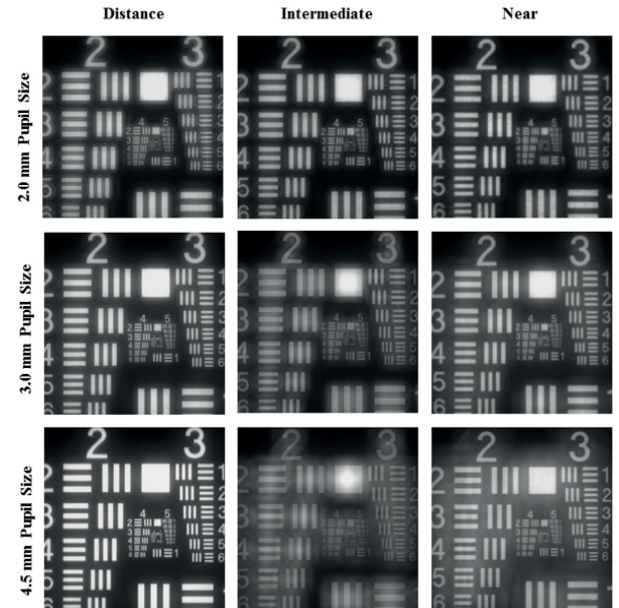

LIGHT TRANSMITTANCE CURVE

compared with natural human lens²

Optiflex TRIO blocks the harmful UV light and filters Violet and Blue light without losing the contrast sensitivity. The transmittance property of Optiflex TRIO is similar to the transmittance of a young human crystalline lens. This graph clearly shows the blockage of harmful UV light and filtration of the Violet-Blue light without losing contrast sensitivity.

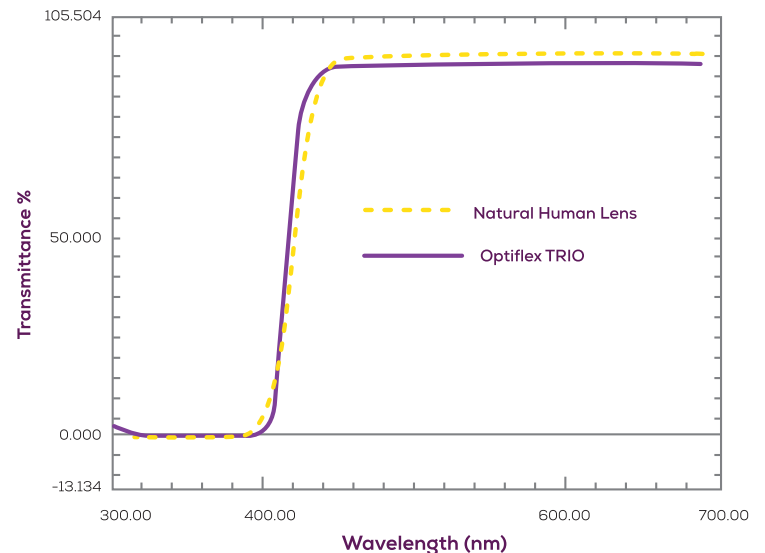

Light Transmittance Graph of Optiflex TRIO compared with natural young human lens

NOTE : Human lens data are from Boettner and Wolter (1962)¹.



SPECIFICATIONS

Model : 3FLA6

MATERIAL	Hydrophobic Acrylic containing Natural Chromophore	
OPTIC TYPE	Single Piece, Diffractive-Refractive, 360° Square Edge with Aspheric Optic	
INTERMEDIATE ADDITION	+1.85 D	
NEAR ADDITION	+3.5 D	
OPTIC SIZE	6.00 mm	
OVERALL SIZE	13.00 mm	
ANGULATION	0°	
ACD	5.28	
REFRACTIVE INDEX	1.48	
RECOMMENDED ULTRASOUND A-CONSTANT	SRK-T 117.97	
RECOMMENDED OPTICAL A-CONSTANTS	SRK - T 118.37	SRK - II 118.61
	Holl 1 Const SF : 1.43	HOFFER Q ACD: 5.22
	HAIGIS α_0 :0.964, α_1 :0.40, α_2 :0.10	Olsen ACD 4.35
DIOPTER RANGE	+7.0 D to +30.0 D (with 0.5 D steps)	
CYLINDER RANGE	0.0 D to 6.0 D (with 1.0D step between 0.0D to 1.0D, with 0.5D step between 1.0D to 1.5D & with 0.75D step between 1.5D to 6.0D)	
IMPLANTATION SITE	Capsular Bag	
STERILIZATION	Irradiation	
SHELF LIFE	4 years from date of manufacture	

MODELS AVAILABLE

Model	Near Addition	Intermediate Addition	Cylinder power		Recommended Range of Corneal astigmatic correction
			At IOL Plane	At Corneal Plane*	
CYL-0.00 D	+3.5D	1.85 D	0.00 D	0.00 D	0.00 D to 0.24 D
CYL-1.00 D	+3.5D	1.85 D	1.00 D	0.68 D	0.25 D to 0.86 D
CYL-1.50 D	+3.5D	1.85 D	1.50 D	1.03 D	0.87 D to 1.25 D
CYL-2.25 D	+3.5D	1.85 D	2.25 D	1.54 D	1.26 D to 1.75 D
CYL-3.00 D	+3.5D	1.85 D	3.00 D	2.05 D	1.76 D to 2.25 D
CYL-3.75 D	+3.5D	1.85 D	3.75 D	2.57 D	2.26 D to 2.75 D
CYL-4.50 D	+3.5D	1.85 D	4.50 D	3.08 D	2.76 D to 3.25 D
CYL-5.25 D	+3.5D	1.85 D	5.25 D	3.60 D	3.26 D to 3.75 D
CYL-6.00 D	+3.5D	1.85 D	6.00 D	4.11 D	3.76 D and above

To choose suitable model, please logon to

 www.biotechcalculators.com

REFERENCES

1. Boettner, E.A. and Wolter, J. R. Transmission of the ocular media. Invest Ophthalmol. 1:776-783, 1962.
2. Data on file with Biotech Vision Care Pvt. Ltd.
3. Data of product evaluation with Biotech Vision Care Pvt. Ltd.





Scan for Surgery
Video



MANUFACTURING FACILITY

BIOTECH EUROPE MEDITECH INC. LIMITED | Unit AF 2, IDA Business & Technology Park,
Gallowstown, Co Roscommon, F42 P862, IRELAND. | Email: intlsales@biotechhealthcare.com | www.biotechhealthcare.com